

f=100 Hz

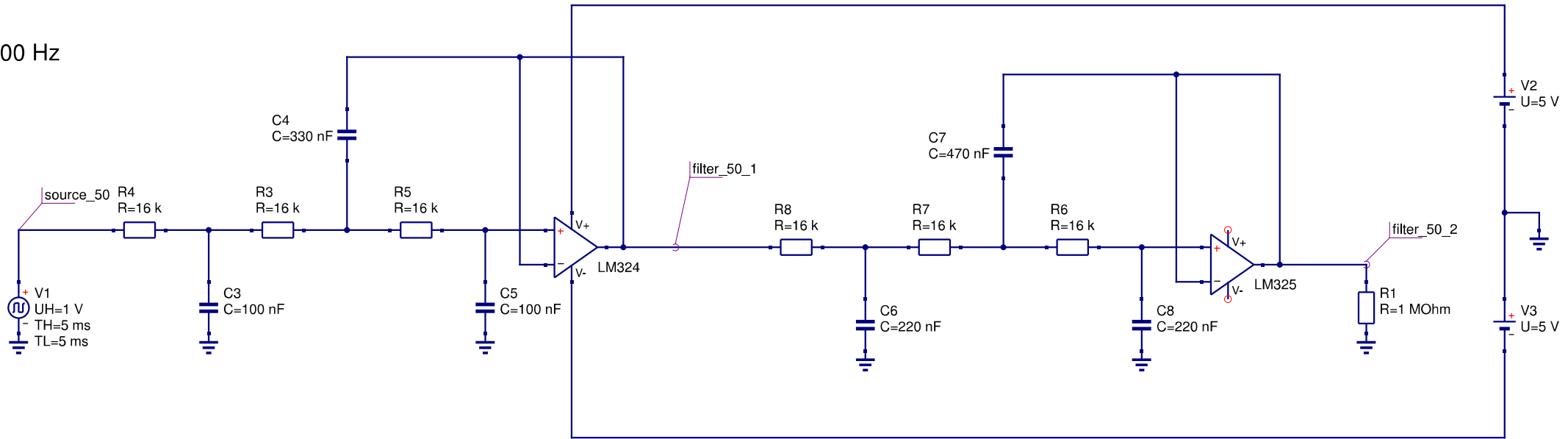

Transient Simulation

TR1
Stop=100 ms
Points=10001

